

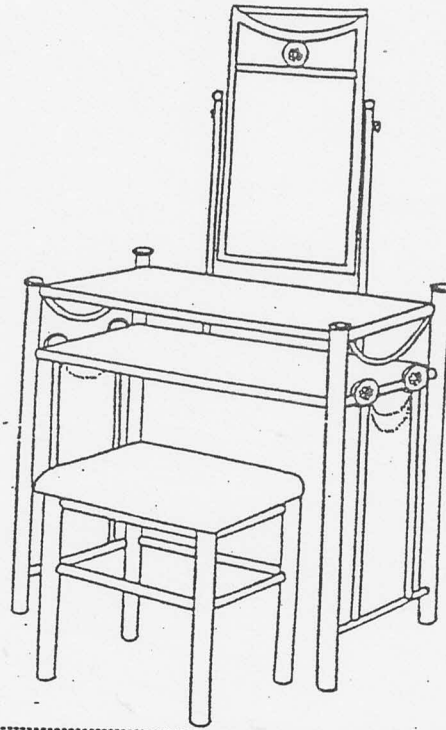







(VANITY)



CARTON :

A) TABLE RIGHT FRAME	1 PC	B) TABLE LEFT FRAME	1 PC
C) CHAIR RIGHT FRAME	1 PC	D) CHAIR LEFT FRAME	1 PC
E) TABLE CROSS PANEL	2 PCs	F) STOOL CROSSBAR	4 PCs
G) MIRROR SUPPORT	2 PCs	H) MIRROR PANEL	1 PC
I) BIG GLASS	1 PC	J) SMALL GLASS	1 PC
K) CUSHION	1 PC		

PART LIST:

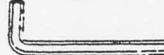
1. BOLT (1/4" x 1")	20 PCs	
2. GLASS PAD	8 PCs	
3. MIRROR'S BEAD	2 PCs	
4. MIRROR'S BOLT	2 PCs	
5. LEG PLUG (3/4")	2 PCs	
6. SCREW (3/16" x 3/4")	4 PCs	
7. LEG CAP (1-1/2")	8 PCs	
8. WRENCH	1 PC	

STEP (CHAIR):

1. INSERT LEG CAP (7) INTO END OF RIGHT FRAME (C) & LEFT FRAME (D).
 2. ATTACH STOOL CROSSBAR (F) INTO RIGHT FRAME (C) & LEFT FRAME (D) WITH BOLTS (1).
 3. SCREW SCREWS (6) INTO STOOL CROSSBAR (F), THROUGH IN CUSHION (K).
-

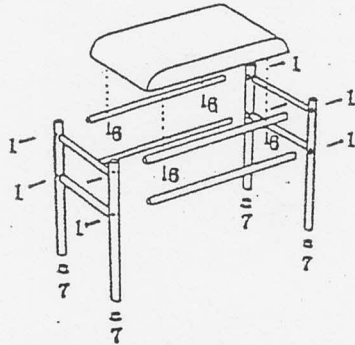

STEP (TABLE):

1. INSERT LEG CAP (8) INTO END OF RIGHT FRAME (A) & LEFT FRAME (B).
 2. ATTACH CROSS PANEL (E) INTO RIGHT FRAME (A) & LEFT FRAME (B) WITH BOLTS (1).
 3. ATTACH MIRROR SUPPORT (G) INTO CROSS PANEL (E) WITH BOLTS (1).
 4. SCREW MIRROR'S BOLTS (4) & MIRROR'S BEAD (3) INTO MIRROR SUPPORT (G), THROUGH IN MIRROR'S PANEL (H).
 5. PLACE GLASS PADS (2) ON CROSS PANEL (E) AND PUT ON BIG GLASS (I) & SMALL GLASS (J).
 6. INSRET LEG PLUG (5) INTO END OF MIRROR'S SUPPORT (G).
-

